

PARTY TENT INSTRUCTION MANUAL

Model NO.:103-1250C

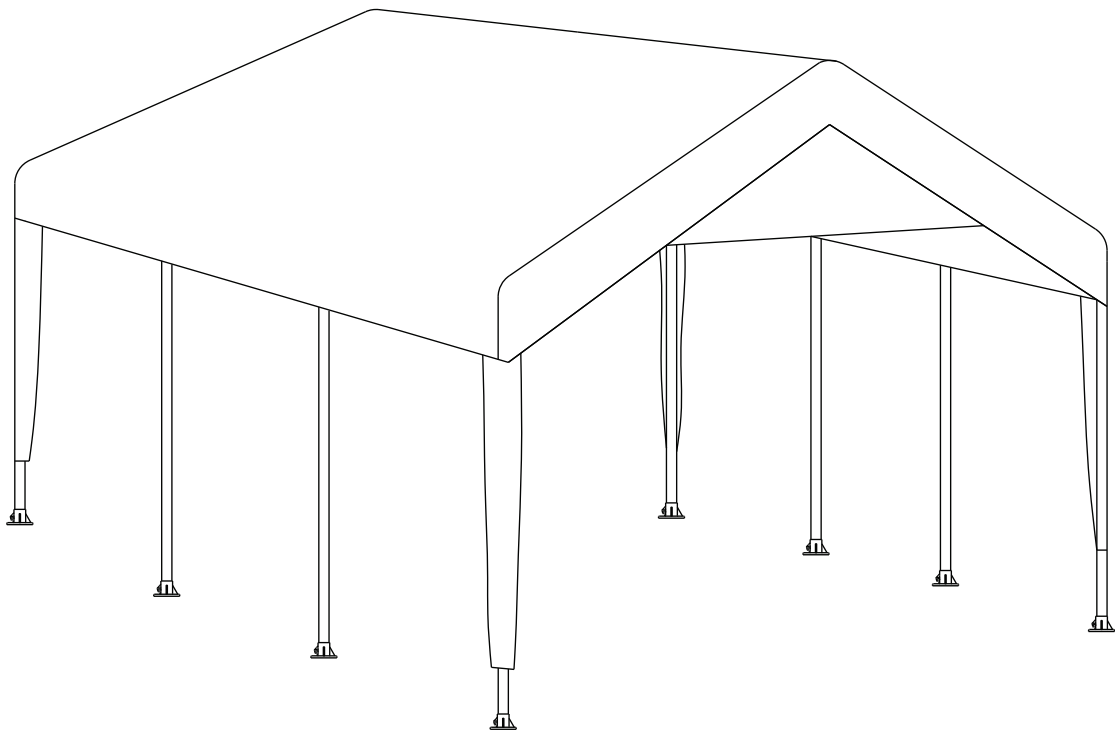





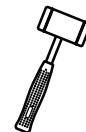



13.1' x 19.6' x 9.2' (4 x 6 x 2.8 m)

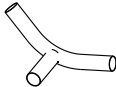

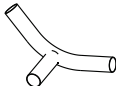
Tools required for assembly (not included)



PARTS LIST

Part#	Description	Drawing	Qty.
1	Leg Tube		8
2	Connecting Tube		17
3	3-Way Peak Connector		2
4	4-Way Peak Connector		2
5	3-Way Side Connector		4
6	4-Way Side Connector		4
7	Foot pads		8
8	Roof Cover		1
9	Ball Tie Down		30
10	Nylon Rope		4
11	Rope Fastening Stake		4

ASSEMBLY PREPARATION

- Place all parts from the packaging box in a cleared area and arrange them on the ground in front of you.
- Remove all packaging materials and place them back in the box. Do not dispose of the packaging materials until assembly is complete.
- Check for completeness and transport damages.

WARNING!



- Do not place the product under trees from which hard fruit such as apples, walnuts or heavy pine cones, etc., may fall. The canopy's cover only protects against normal leaves and light debris, whereas large branches or other falling items may puncture or tear the cover material.
- Keep children away during assembly. This product contains small parts which can be swallowed by children.
- Do not attempt to assemble the product if any parts are missing.
- At least 2 people are needed to complete the assembly as some of the steps require heavy lifting.



ASSEMBLY

Tools required for assembly (not included)

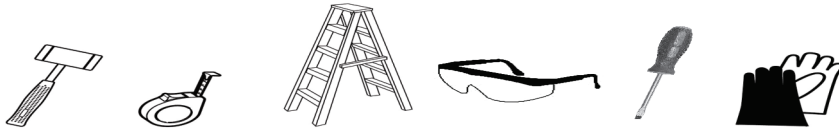

Step 1

- Lay out the roof frame parts as shown below.
- Please note:
The Parts #2 are used to form the side and peak.
The Parts #2 are used to form the roof rafter.

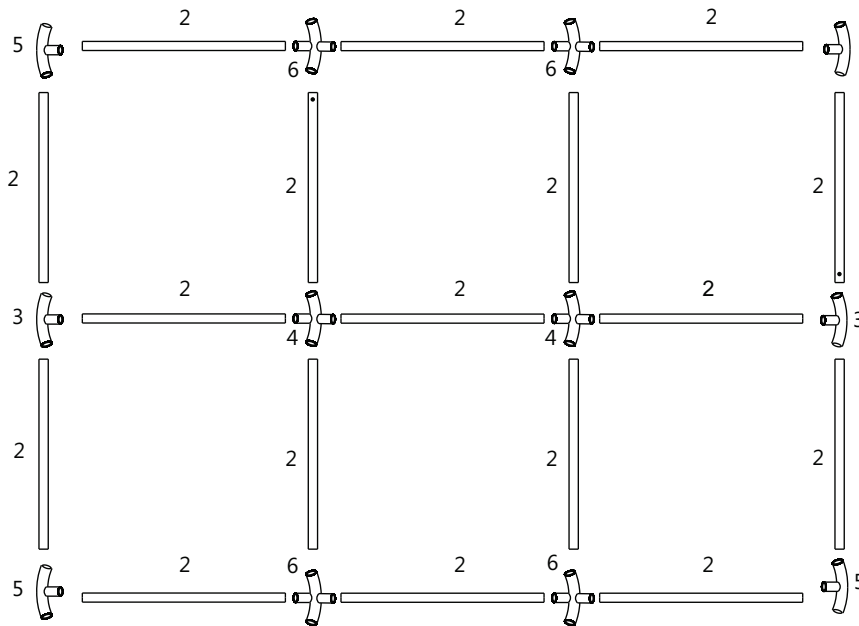

- Start with the center and complete the center frame first. Then assemble each side.

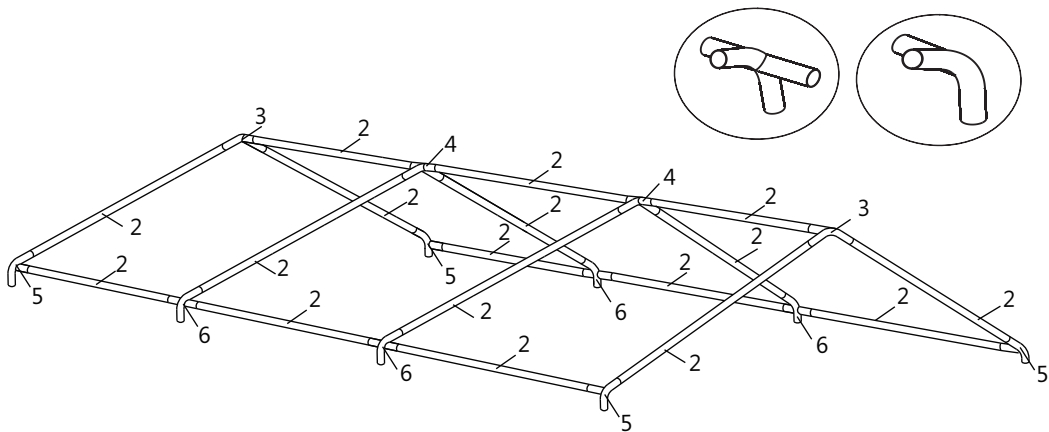

Step 2

- Connect 4 legs of one side to the 4-way and 3-way connectors.

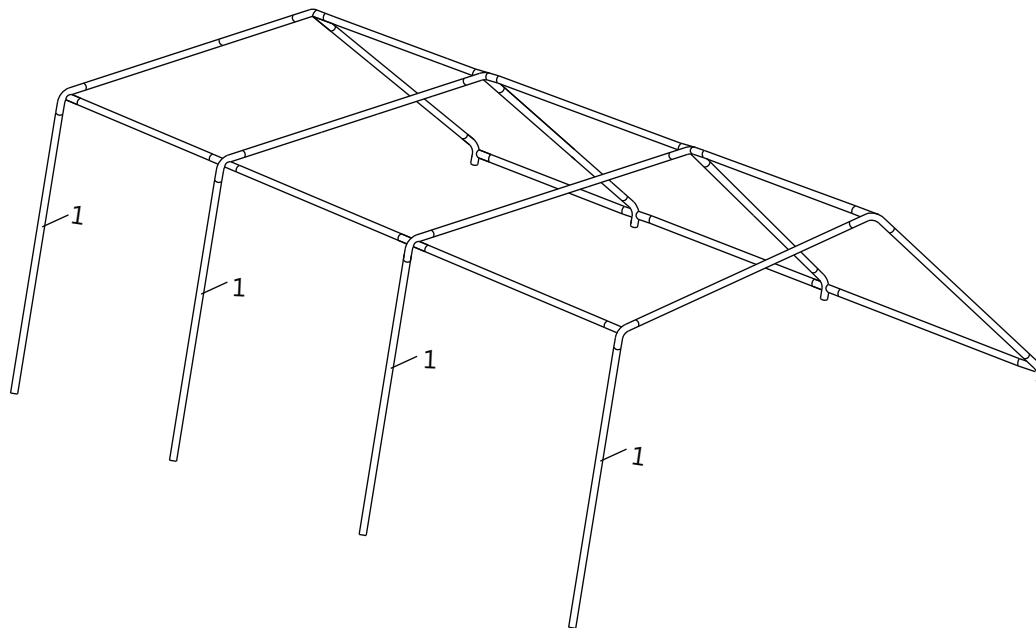

Step 3

- Unfold the cover with the grommets toward the cover's bottom and place the cover over the frame. The flared edges should be located at each of the 4 corners of the frame.

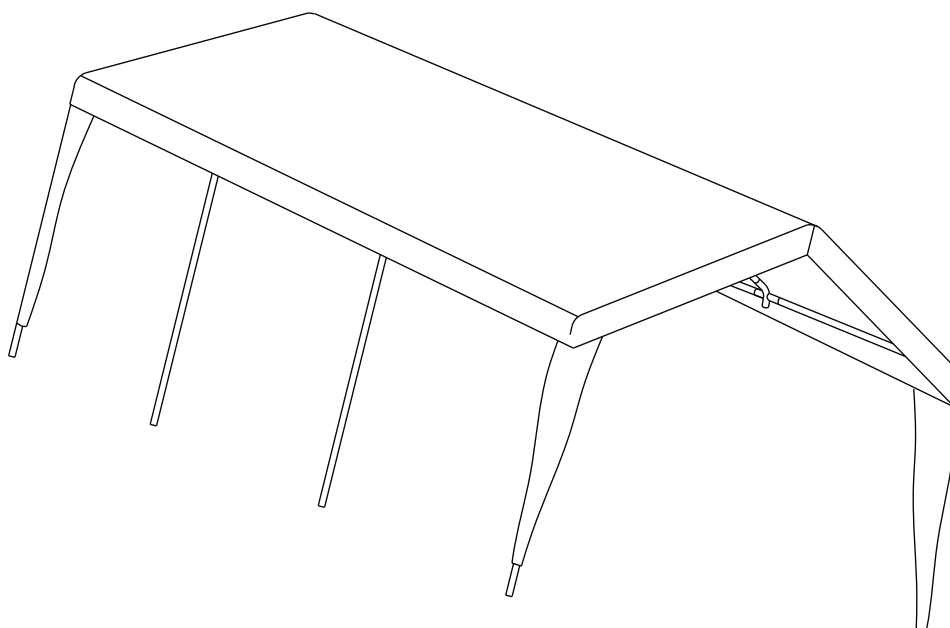

Step 4

- Connect the 4 legs for the other side the same way. And then attach the cover to the frame with ball tie downs.
- To properly install a bungee and starting at the four corners of the cover:
Insert the ball tie downs into the eyelets and wrap the cord around the tube and hook it over the ball.

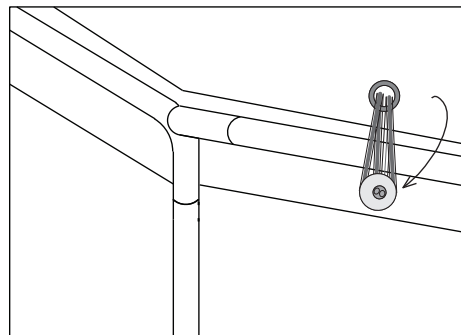
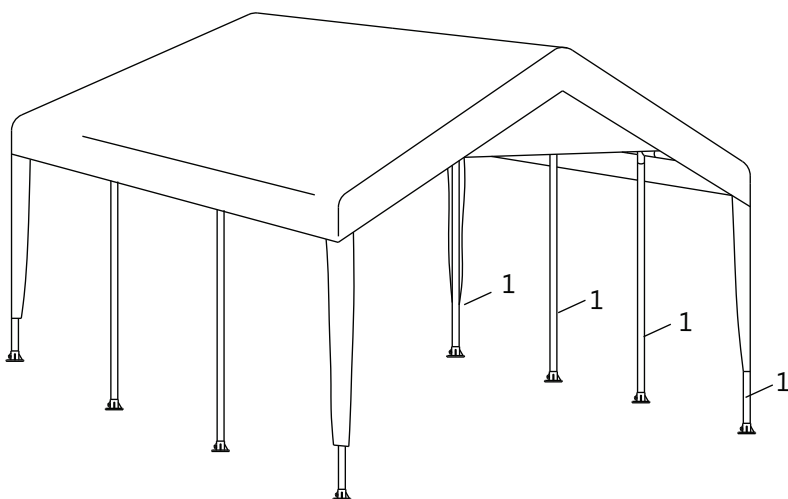

Step 5

- Insert the eight legs into the foot pads. And then attach the S-hook of the leg skirt to the foot pads.

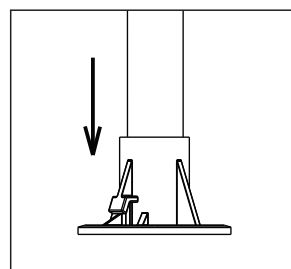
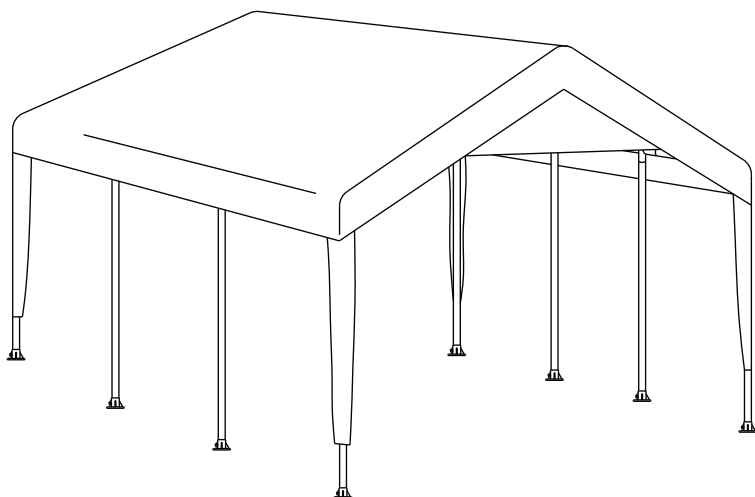

Step 6

- Measure out at least 36in from each leg. Screw each anchor into the ground leaving 2in between the ground and the eye of each anchor. We strongly recommend that your unit be anchored 36in from each leg although this may not be possible in all cases. DO install anchors as close to 36in away from legs as possible.
- This canopy is designed for use as a temporary structure. After assembly, the canopy MUST BE securely chored to the ground to prevent damage from winds.
- Tie anchor cable or rope around the connector at the top of each leg of the canopy.
- Securely tie the other end of the cable or rope through the eye of the anchor and pull tight.
- Now, continue to screw each anchor into the ground until the eye of the anchor is flush with the ground. This will secure the anchor rope even tighter.

NOTE: You should check and tighten the rope frequently to ensure maximum stability of your canopy and to protect against wind damage.

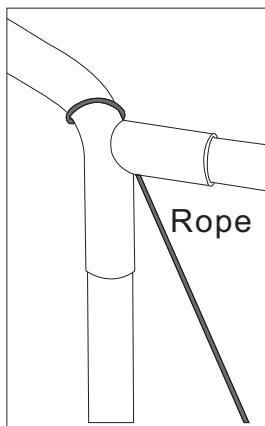
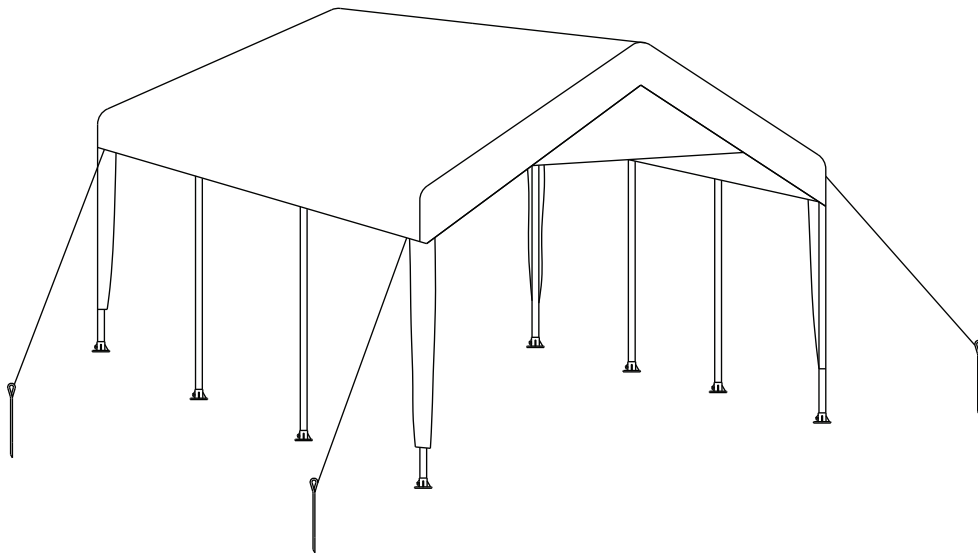

ANCHOR KIT NOT INCLUDED WITH THIS CANOPY

