

# ASSEMBLY INSTRUCTION







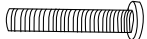
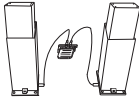

PARTS LIST							
A	TABLE RIM		1	F	BOLT(M8X50)		8
B	SUPPORTING TUBE		1	G	METAL WASHER(M6)		10
C	TABLE BASE		1	H	METAL WASHER(M8)		8
D	BOLT(M6X25)		8	I	ALLEN WRENCH(M6)		1
E	BOLT(M6X35)		2	J	ALLEN WRENCH(M8)		1

Diagram:

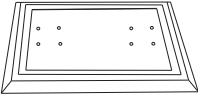
step:1

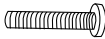

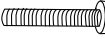
step:2

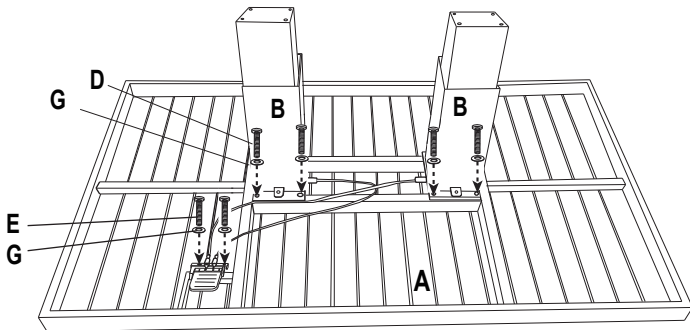
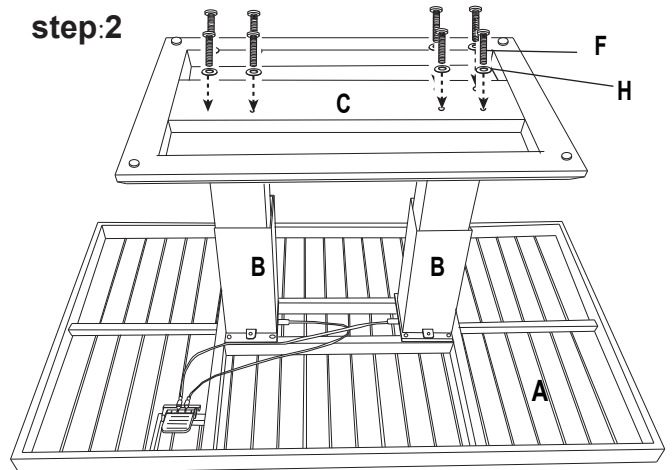

step:3

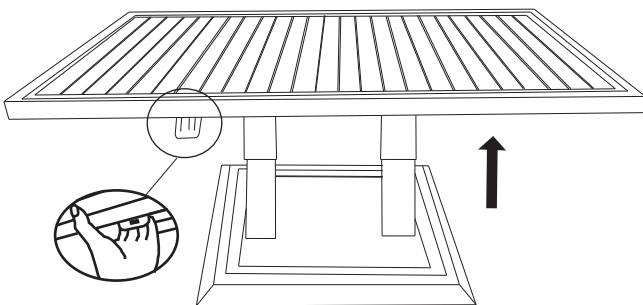

Press and hold the button as the table rises

step:4

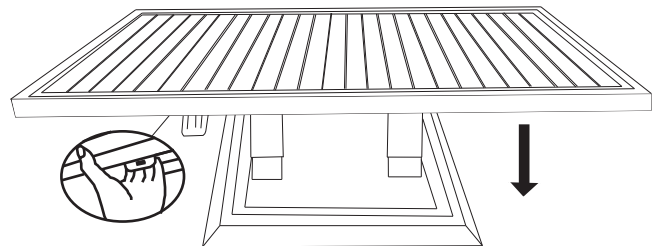

Press the button as the table descends and press down with your hand on the center of the table as shown