

CD Battery Charger

User's Manual



www.tuv.com
ID 100000000











Please read this User's Manual thoroughly before using the charger.









I PRODUCTS OVERVIEW

- ◆ **Auxiliary function for start-up. it can be used for charging and starting the lead-acid batteries and batteries for motorcycles. Automobiles. tractors and ships.**
- ◆ **Installed with input fuse and output fuse. grounding wire connected to the power cables. safe and reliable.**
- ◆ **Installed with controlling switches for charging current and startup. adjustable current, functioning fully.**
- ◆ **Installed with two wheels and handle, featuring its movability and easy operation.**









II TECHNICAL PARAMETERS

Zhejiang Kende Mechanical & Electrical CO., LTD.		
<small>ADD: Shuiquetou Industrial Zone, Shugang Road Cross Dongfang Road, Pengjie Town, Luqiao district Taizhou, Zhejiang 318057, P.R. China</small>		
     IP20	Battery charger	EN60335-2-29
	CD-220	BJ 2013
		I₂boost 20A I₂min 12A
	 	Battery Min.70Ah Max.300Ah
		START: 130A 3S ON 120S OFF
		FUSE 15A (INPUT) FUSE 2X80A (OUTPUT)
	Input:	230V~ 50Hz, 605W, 1.7/3.1A
	Output:	12.0V d.c., 16A 24.0V d.c., 18A
	Warnings: <ul style="list-style-type: none"> • Disconnect the supply before making or breaking the connections to the battery. • WARNING: Explosive gases. Prevent flames and sparks. Provide adequate ventilation during charging. 	









CD-220 Nameplate

Zhejiang Kende Mechanical & Electrical CO., LTD.		
<small>ADD: Shuiquetou Industrial Zone, Shugang Road Cross Dongfang Road, Pengjie Town, Luqiao district Taizhou, Zhejiang 318057, P.R. China</small>		
     IP20	Battery charger	EN60335-2-29
	CD-320	BJ 2013
		I₂boost 30A I₂min 15A
	 	Battery Min.80Ah Max.450Ah
		START: 170A 3S ON 120S OFF
		FUSE 20A (INPUT) FUSE 3X80A (OUTPUT)
	Input:	230V~ 50Hz, 810W, 2.1/3.9A
	Output:	12.0V d.c., 20A 24.0V d.c., 22A
	Warnings: <ul style="list-style-type: none"> • Disconnect the supply before making or breaking the connections to the battery. • WARNING: Explosive gases. Prevent flames and sparks. Provide adequate ventilation during charging. 	

CD-320 Nameplate

Zhejiang Kende Mechanical & Electrical CO., LTD.			
ADD: Shuiquetou Industrial Zone, Shugang Road Cross Dongfang Road, Pengjie Town, Luqiao district Taizhou, Zhejiang 318057, P.R. China			
     	Battery charger CD-420	EN60335-2-29	
	 	BJ 2013	l₂boost 40A l₂min 17A
		Battery Min.100Ah Max.600Ah	START: 250A 3S ON 120S OFF
		FUSE 20A (INPUT) FUSE 3X80A (OUTPUT)	Input: 230V~ 50Hz, 920W, 2.2/4.3A
		Output: 12.0V d.c., 25A 24.0V d.c., 27A	Warnings:
		<ul style="list-style-type: none"> • Disconnect the supply before making or breaking the connections to the battery. • WARNING: Explosive gases. Prevent flames and sparks. Provide adequate ventilation during charging. 	









CD-420 Nameplate

Zhejiang Kende Mechanical & Electrical CO., LTD.			
ADD: Shuiquetou Industrial Zone, Shugang Road Cross Dongfang Road, Pengjie Town, Luqiao district Taizhou, Zhejiang 318057, P.R. China			
     	Battery charger CD-520	EN60335-2-29	
	 	BJ 2013	l₂boost 50A l₂min 17A
		Battery Min.120Ah Max.750Ah	START: 300A 3S ON 120S OFF
		FUSE 25A (INPUT) FUSE 4X80A (OUTPUT)	Input: 230V~ 50Hz, 1050W, 2.6/4.6A
		Output: 12.0V d.c., 25A 24.0V d.c., 30A	Warnings:
		<ul style="list-style-type: none"> • Disconnect the supply before making or breaking the connections to the battery. • WARNING: Explosive gases. Prevent flames and sparks. Provide adequate ventilation during charging. 	

CD-520 Nameplate

Zhejiang Kende Mechanical & Electrical CO., LTD.

ADD: Shuiquetou Industrial Zone, Shugang Road Cross Dongfang Road, Pengjie Town, Luqiao district Taizhou, Zhejiang 318057, P.R. China

     IP20	Battery charger CD-620	EN60335-2-29
		BJ 2013
		I₂boost 60A I₂min 20A
		Battery Min.140Ah Max.900Ah
		START: 320A 3S ON 120S OFF
	Input:	230V~ 50Hz, 1200W, 2.6/5.8A
	Output:	12.0V d.c., 30A 24.0V d.c., 35A
	Warnings: <ul style="list-style-type: none"> • Disconnect the supply before making or breaking the connections to the battery. • WARNING: Explosive gases. Prevent flames and sparks. Provide adequate ventilation during charging. 	

CD-620 Nameplate

III DIAGRAM FOR CURRENT REGULATING

CD-220

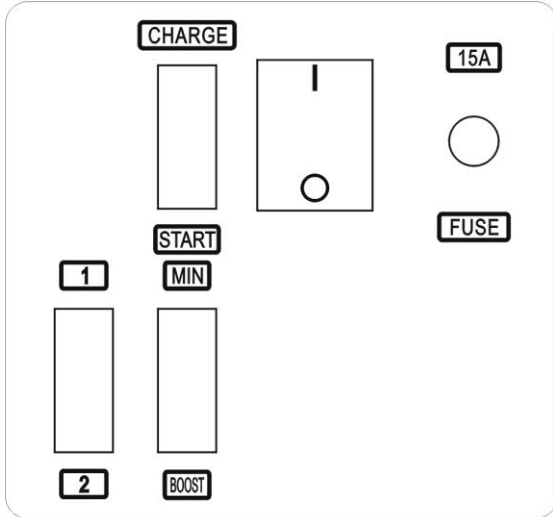

CD-320 CD-420

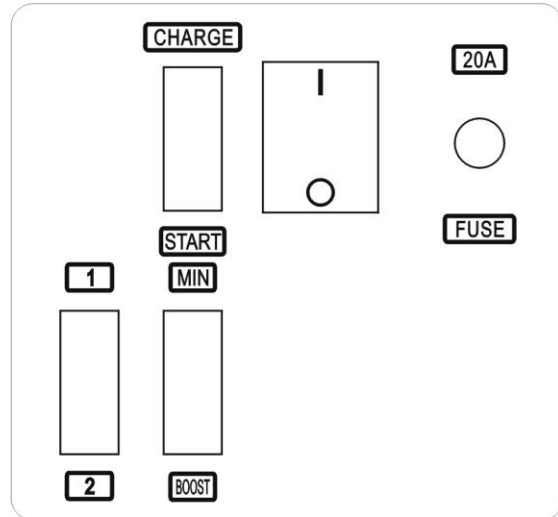

CD-520

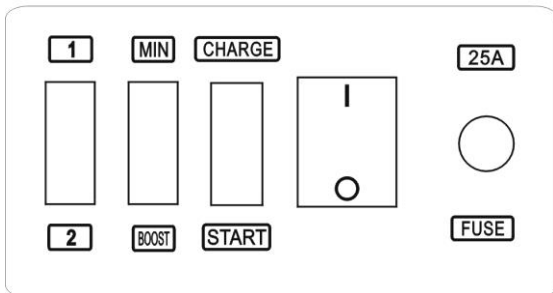

CD-620

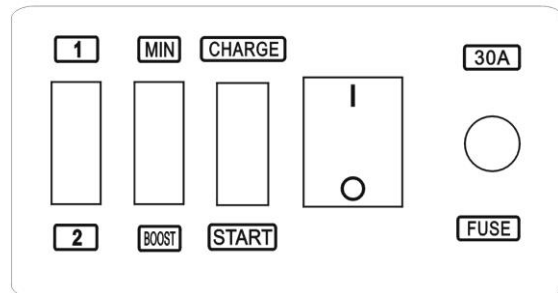

CD-520 CD-620 TIMER

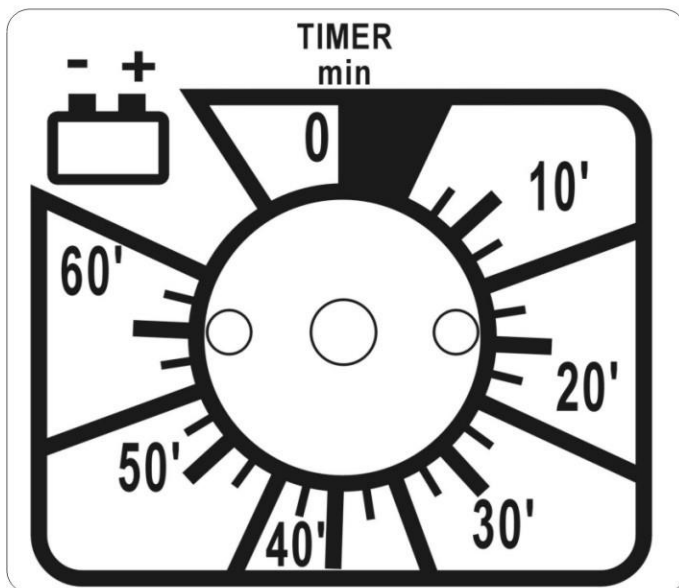

IV INDICATIONS AND SYMBOLS FOR THE MACHINE

EN60335-2-29: Standards for charger

 : Single-phase transformer-rectifier

 : Symbol of battery

 : Read the User's Manual carefully before use.

 : Inside use only

IP20: Protection class

I_2 min: DC Min output current

I_2 boost: DC Max output current

CHARGE: Battery Charge

START: Start current(ON:3S, OFF:120S)

MIN+1: Smallest Current For Charger

MIN+2: Rated Current For Charger

BOOST+1: Lager Current For Charger

BOOST+2: Lagerest Current For Charger

V SAFETY REGULATIONS

For the safety of persons and properties, the following safety regulations must be observed when the charger is used.

- 1、 As the flammable gas can be generated in the course of charging, the battery should be charged inside the room with good ventilation. Flames and sparks should be kept away and smoking is prohibited.**
- 2、 For the protection class is IP20, the product shall not be used outside the room, where it is the rainy and snowy.**
- 3、 The grounding wire must be connected to the socket so that the pin for grounding inside the plug can be reliably earthed.**
- 4、 In the course of charging, the charger should be put at a level place and should not be tilted or reversely placed.**
- 5、 As the casing can generate heat during charging, it is prohibited to cover the vent of casing.**
- 6、 The instructions for the battery and transportation tools should be strictly followed in the course of charging.**
- 7、 The battery should be mounted or dismantled after the power is turned off.**
- 8、 The maintenance for the charger should be done by the professionals.**
- 9、 The fuse and cable with the same specifications should be used when they need to be replaced.**
- 10、 The power socket should be connected with the grounding wire so that the pin of power cord can be reliably earthed.**
- 11、 The battery clamps should not be contacted with each other.**
- 12、 The cover of battery should be opened in the course of charging.**
- 13、 It is prohibited to connect the battery clamps reversely. (e.g., wrongly connect the red clamp of anode to the cathode of battery, or wrongly connect the black clamp of cathode to the anode of battery)**
- 14、 It is prohibited to use the charger for the charging of non-charging batteries.**
- 15、 The fuse with the same specifications as the original configuration should be used when they need to be replaced. Do not use other conductors to replace the fuse.**
- 16、 In case the power cable is damaged, the damaged cable should be dismantled and replaced by professionals for maintenance.**
- 17、 If the supply cord is damaged, it must be replaced by the manufacturer, its service agent or similarly qualified person in order to avoid a hazard.**
- 18、 The battery terminal not connected to the chassis has to be connected first. The other connection is to be made to the chassis, remote from the battery and fuel line. The battery charger is then to be connected to the supply mains.**
- 19、 After charging, disconnected the battery charger from the supply mains. Then remove the connection the charger and the battery.**
- 20、 The product construction was same as the previous approved types in 15013894, the only difference is that plugs not used, and the product is intended to be permanently connected to fixed wiring. -a statement in the instructions that a disconnection incorporated in the fixed wiring is to be provided.**

VI OPERATION INSTRUCTIONS FOR CHARGER AND BATTERY

To ensure that the charger and battery are used correctly and the machine is kept from damage, the following rules must be followed:

1、 Operation instructions for the battery

- **When battery does not have sufficient electricity. the terminal voltage of it can be normal, which means the 12V battery has the terminal voltage of 12V and the 24V battery has the terminal voltage of 24V. The main physical phenomenon. which indicates the insufficient electricity in the battery. is the change of the specific gravity of the battery solution. Normally, when the specific gravity of the battery solution is 1.28KG/L, the electricity volume of battery is sufficient. If it is lower than 1.16KG/L, the battery is empty and won't have any electricity.**
- **The voltage of battery can be deviated from the normal value only when the battery is loaded or charged. When loaded, the voltage is lower than normal value of terminal voltage, whereas it is higher than normal value when the battery is being charged. If the battery is topped for some time (about 10-30 minutes) after it is loaded, and the terminal voltage is still lower than normal value, the battery may have quality defects.**
- **Remove the cover of the battery to see if the electrolytic solution in it is sufficient. If not, add more distilled water into it till it is sufficient so as to make it prepared for charging.**
- **As the electrolytic solution in the battery is dilute sulfuric acid and strongly erosive, it can't contact the skin or clothes. In case the electrolytic solution has contacted the skin, the contacted area should be washed with water immediately and the contacted person should be sent to the hospital for medical treatment timely.**

2、 Correct charging method

- **It is permitted to charge the batteries with the same capacities in parallel connection or when connected in series. The terminal voltage of battery in parallel**

connection or connected in series must match the output voltage of the charger.

Normally, it is recommended to charge the batteries when they are connected in series so as to ensure the current passing each battery has the same value.

- **Connecting the batteries:** Connect the (red) anode of battery clamp to the anode of the battery and the corresponding terminal (12V or 24V) of the charger. Connect the (black) cathode of battery clamp to the cathode of the battery. If the battery of the car needs to be charged, first you should connect the charger to the terminal which is not connected with the chassis, then connect the other terminal of charger to the chassis. The connecting points must be far away from the battery and fuel tubes.

- **Insert the power plug.** First turn the power switch to “I” position, then turn the function switch “charge/start” to “charge” position. The ammeter will indicate the reading for the current (fit for CD-220,CD-320,CD-420). CD-520 and CD-620 has the options for charging time. For details, please refer to *Section XII-Diagram for Current Regulating*.

- **In the course of charging, the temperature of electrolytic solution in the battery should not be more than 45°C.** If the charging is not finished and the temperature reaches 45°C, the charging current should be lowered down so as to prolong the charging time and make the temperature of electrolytic solution not increase continuously until the charging is completed.

- **The following phenomena may occur after charging is finished:** Specific gravity of battery solution is close to 1.28KG/L; Terminal voltage of battery is increased to more than 14V (or 28V); Electrolytic solution is heavily bubbled up.

- **After the charging is finished, the power should be turned off first, and then the battery clamp should be removed from the battery.**

3、Auxiliary start

Note: Auxiliary start must be carried out by strictly following the operation procedures specified for the product.

- **First use the charger to fast charge the battery for 10-15 minutes.**

- **Connect any pole of the charger to the engine's terminal not linked to the chassis (with same poles, meaning the anode should be connected with anode), connect the other pole to the engine's terminal which is linked to the chassis.**
- **Read the related instructions for the engine as provided by the manufacturer carefully.**
- **Insert the power plug, turn the power switch to "ON" position, then turn the function switch "charge/start" to "start" position. And the engine can be started.**

Attention: The start time for each time is 3 seconds; the start for the second time should be 120 seconds later. Five times of cycled start are available. If the engine is continuously started, 10 minutes of interval must be ensured between two start cycles so that the transformer inside the device can be cooled for restarting the engine.

XII MAINTENANCE

- **Regular maintenance and repair work can ensure the machine is properly used and its condition complies with the safety requirements.**
- **Any improper or incorrect operation may cause the failure and damage for the machine.**
- **The warranty period for the machine is one year commencing from the date of purchasing. Within this time, users can take the machine with the invoice to the distributor or the designated department for repair.**
- **Before the maintenance work for machine is started, the operator must turn off the main power at power distribution cabinet and the power switch of the machine.**
- **If the transformer is heating and no current is available from the transformer due to the over current in the course of charging, it is because the over-heat protection device inside the charger is started to protect the transformer. In this case, the user should wait till the transformer is cooled to resume the charging process.**

VIII ELECTRIC DIAGRAM

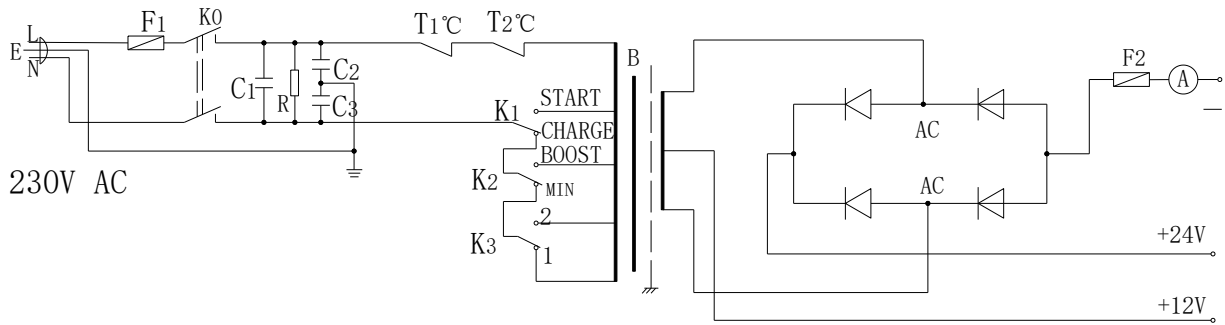

CD-220、CD-320、CD-420 Electric diagram

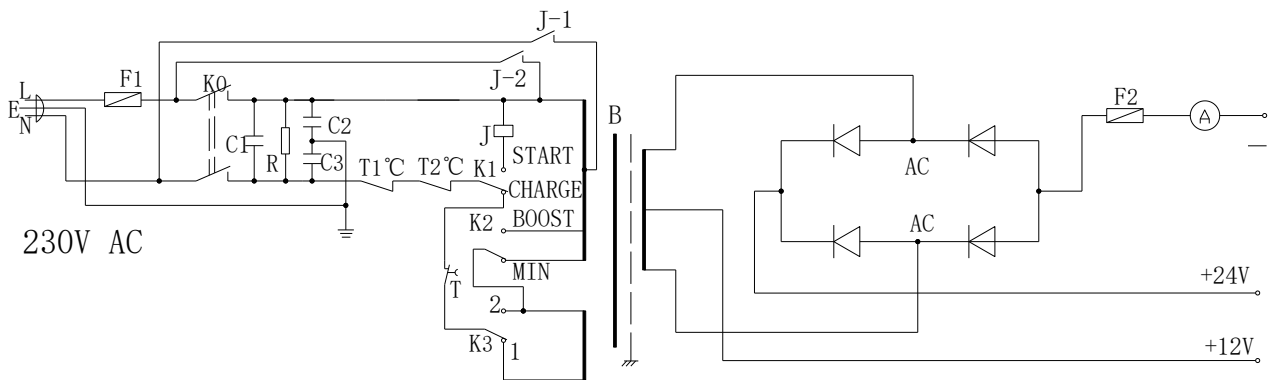

CD-520、CD-620 Electric diagram

IX Charging and Starting-up Instruction

I.Charging Procedure

- a、 Select the charging voltage of charger (12V or 24V), connect charger's anode (+) and cathode (-) with batter's correspondent poles.
- b、 Plug into the attaching plug:
 - 1) Select function switch of "MIN/BOOST", and place it on "MIN";
 - 2) Select the MIN (1) or MAX (2) current on another function;
 - 3) Select "charge/start-up" function switch, and place it on "charge"
 - 4) Turn the power switch on, and make charging.
- c、 Select the charging time function of "Time/Untime" (Only CD-520; CD-620 is limited)
- d、 When charging completed, turn the power switch off, plug off attaching plug, and take off batter clamp from the charger.

II. Starting-up Procedure

- a、 First operate according to the item a and item b of the charging procedure, then select the function switch "MIN/BOOST", place it on 'BOOST' position and charge the battery quickly for 10 to 15 mins. b、 Place the function switch "Charging/Starting-up" to "Starting-up". (starting time and circle should conform to the *Aid Starting-up Instruction*)
- c、 When starting-up completed, turn the power switch off, plug off attaching plug, and take off batter clamp from the charger.

III.Warnings:

- a、 When charging motorcar, first connect the disconnected end of the motorcar chassis, then connect the charger to the other end of motorcar chassis, and meanwhile keep connection point away from battery and fuel pipe.
- b、 When starting-up motorcar, connect any pole of the charger to the disconnected end of motorcar chassis (make sure like polarity, namely the anode and cathode be connected correspondently), and the other pole be connected to the other end of motorcar chassis. Please read the starting-up instruction from traffic tools manufactures carefully before you start-up motorcar.