

# AUTO STORAGE SHELTER INSTRUCTION MANUAL

Model NO.:103-1224

12' x 24' x 9.2' (3.8 x 7.5 x 2.8 m)



**Tools required for assembly (not included)**



## TABLE OF CONTENTS

IMPORTANT SAFETY INSTRUCTIONS .....	2
INTENDED USE .....	2
PARTS LIST.....	3
ASSEMBLY PREPARATION .....	3
ASSEMBLY .....	4-8

## IMPORTANT SAFETY INSTRUCTIONS



### WARNING!

- Read all safety instructions to reduce the risk of injury or death.
- This is a temporary structure and is not recommended as a permanent structure.

- Choose your shelter's location carefully. Check for overhead utility lines, branches, etc. DO NOT install near roofs or other structures that may shed snow, ice or excessive run-off onto your shelter. Keep away from electrical wires!
- Install your shelter on a level surface.
- Check municipal by-laws prior to setting up the product.
- Have an overview of all parts before attempting installation. Make sure all components are available.
- DO NOT use this product in environments for which it is not intended (i.e. extreme cold, high winds, extreme heat, heavy rainfall, etc).
- Always wear safety glasses when assembling this product. Wear gloves when working with tubing to prevent cuts or abrasions.
- **Caution!** Anchors must be used with all shelters. Covers should NOT be installed on any product until it has been properly anchored to the ground.
- Proper anchoring and keeping cover tight and free of snow and debris, is the responsibility of the consumer. Damages caused by improper anchoring are not covered under warranty.
- **Warning!** Keep all flame and heat sources away from the shelter fabric. The fabric will burn if left in continuous contact with a flame source.
- DO NOT use open flames or cooking or heating devices inside or in close proximity to the product, including all types of stoves, gas heaters, gas lanterns, citronella torches, mosquito coils, etc.
- **Warning!** In order to reduce risk of burning and avoid damage, DO NOT
  - cook, smoke, refuel or use any open flame devices in or around the shelter.
  - store flammable liquids (gasoline, kerosene, propane, etc.) in the shelter.
  - operate gas powered vehicles/equipment in or around the shelter.
- Keep open flames a safe distance away from the shelter.
- DO NOT use hard-edged tools or instruments, such as rakes or shovels, to remove snow. These can cause punctures to the cover.
- NEVER start the engine of any vehicle or machine inside a closed shelter. Ensure that there is adequate ventilation for starting engines and for any work with paints, cleaners, etc.
- This shelter is NOT designed to support heavy snow or ice loads. Snow or ice accumulation may cause your shelter to collapse. To avoid overload, brush snow and ice off the roof top with a broom or mop.
- To prevent collapse, damage to property, personal injury and/or death, NEVER clear the roof of snow or debris from inside the shelter.
- DO NOT use bleach, alkaline or harsh detergents for cleaning. Doing so will damage the polycarbonate material. Soap and warm water are recommended.











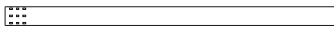
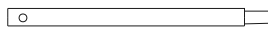

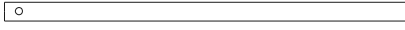
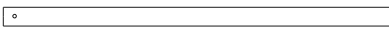
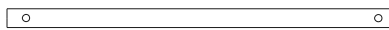











## IMPORTANT! READ CAREFULLY AND RETAIN FOR FUTURE REFERENCE

### INTENDED USE

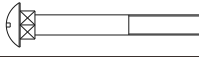
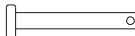
This temporary shelter is intended to offer protection from damages caused by the sun, light rain, light snow, tree sap, bird and animal excrements. Do not use it to shield goods from high winds, heavy snow or ice storms. Only use it for its intended use.

**PARTS LIST**

Part#	Description	Drawing	Qty.
1	Leg tube(top part)		14
2	Leg tube(Center Bottom Part)		10
3	Bet Corner Leg		4
4	Rafter Tube		14
5	Horizontal Tube		18
6	Bottom Cross Rails		12
7	3-Way Peak Connector		2
8	4-Way Peak Connector		5
9	3-Way Side Connector -Left		2
10	3-Way Side Connector -Right		2
11	4-Way Side Connector		10
12	4-Way Cover Rail Clamp		20
13	3-Way Cover Rail Clamp		8
14	15" Anchor		4
15	Foot Plate		10
16	Cable Clamps		4
17	Cable-1'Lengths		4
18	Roof Tarp		1
19	Door Panel with Zipper		1
20	Back Panel		1
21	M6 Washer		38
22	M6 Nuts		38
23	M6X50 Bolts		38
24	Pin Bolt		10
25	Open Pin		10
26	Ratchet		8
#	Owner's Manual		1

"#" Indicates a non-illustrated part

## ASSEMBLY PREPARATION

- Place all parts from the packaging box in a cleared area and arrange them on the ground in front of you.
- Remove all packaging materials and place them back in the box. Do not dispose of the packaging materials until assembly is complete.
- Check for completeness and transport damages.

### WARNING!



- Do not place the product under trees from which hard fruit such as apples, walnuts or heavy pine cones, etc., may fall.
- Keep children away during assembly. This product contains small parts which can be swallowed by children.
- Do not attempt to assemble the product if any parts are missing.
- At least 3 people are needed to complete the assembly as some of the steps require heavy lifting.

## ASSEMBLY



### WARNING!

- Do not leave the shed unattended during assembly. Otherwise, personal injury or damage to the shed may occur!

### Frame assembly overview

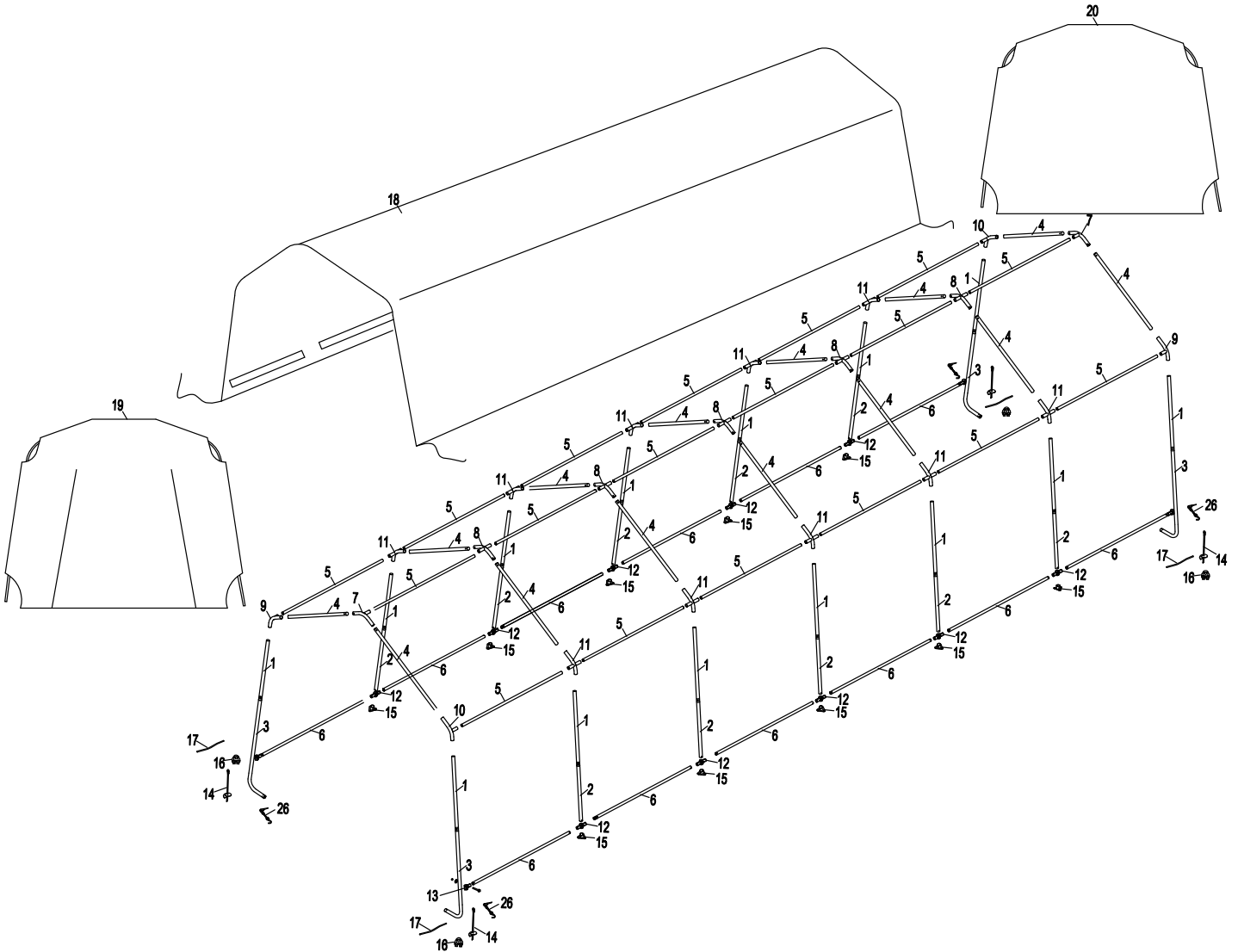

### Step 1: Preparing the Roof Parts

Select level and suitable location for your shelter.  
Layout the roof parts as shown in Diagram B.

Diagram B

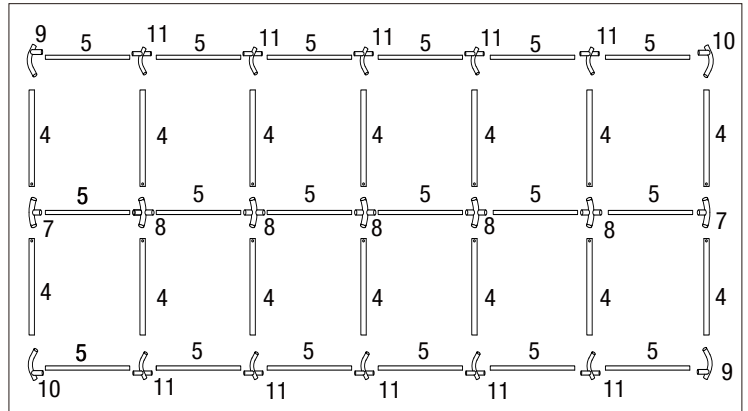

*Please pay attention to the differences to the 5 connectors with reference to Diagram C below (connectors are also individually numbered).*

**Note:**

1. When installed, the welded socket for the cross rail must be below the bend.
2. Parts #9, #10, #11 are Side bend connectors with sharp bend.
3. Parts #7 & #8 is top bend connectors with sloping bend.

Diagram C

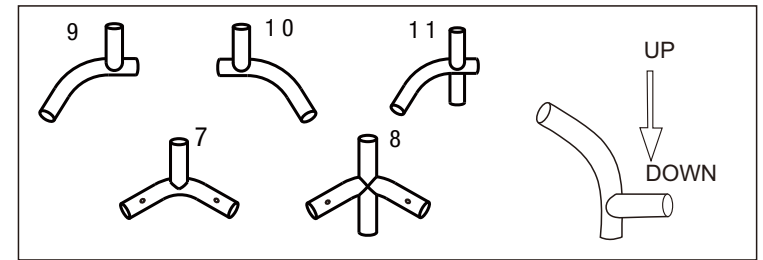

### Step 2: Assembling the Roof

Assemble the roof frame by connecting the parts lay out in the above.

**Note:**

1. The hole end on Part #4 needs to be connected to Part #7 and #8 (See Diagram D1 & D2) by the fittings #21, #22 and #23.
2. Use #5 pipe to connect part #7, part#8. ( See Diagram D)
3. Use a rubber or wooden mallet to ensure all pipes are fully inserted.

Diagram D

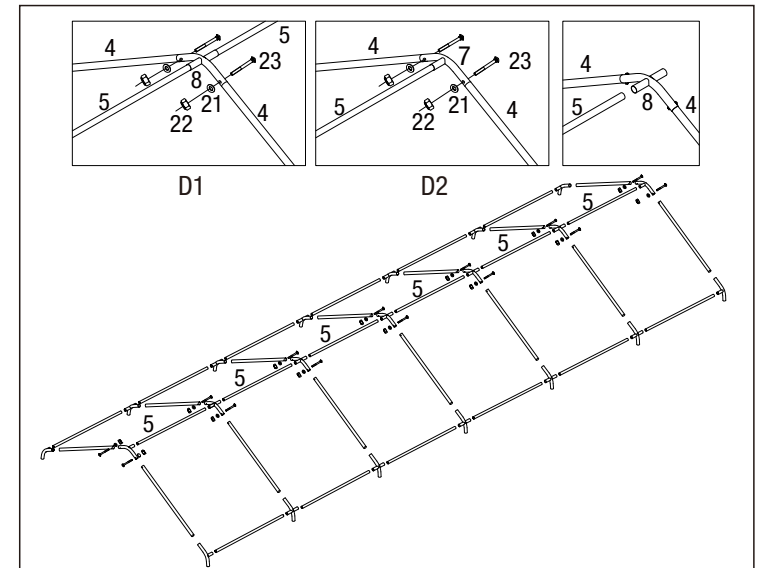

### Step 3: Attaching the legs

There are 14 legs for the whole shelter.

- a. Follow Drawing E1 connected tube #1, & #3 to get the 4 Corner Legs.
- b. Tubes #1, & #2 are the ten center legs.
- c. Insert the Center Legs into the Foot Plate (#15). Align holes in the pole and foot plate, push the Pin Bolt (#24) through all the holes, Insert the cotter pin (#25) and split the tongues of the cotter pin with a slot screwdriver to secure this connection. (See Diagram E2, E3 # E4)
- d. Insert the prepared Center Legs and Corner Legs into the side connectors as Diagram E5.

Diagram E

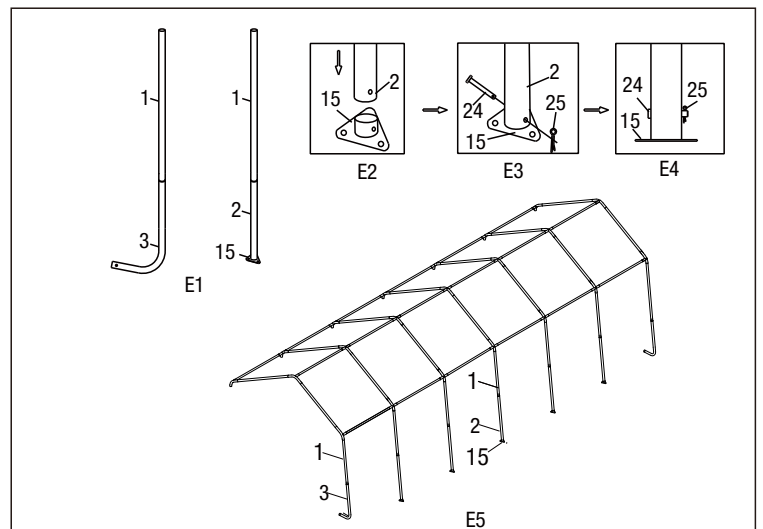

- e. Repeat to assemble the other side as shown in Diagram F.

Diagram F

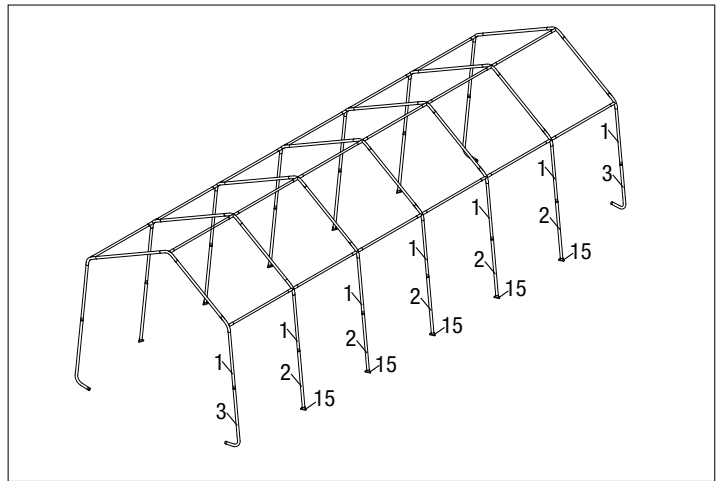

**Step 4: Assemble Bottom Cross Rails**

- a. Install the Bottom Cross Rails(#6) between each two legs with Cover Rail Clamps (Part#12 & #13) by the fittings (Part #21, #22 & 23). Part #12 is for Center Legs, and #13 is for Corner Legs. (see Diagram G)
- b. Slide the cross rails so that they are both 10" up from the ground. And only hand tighten the bolts now.

Diagram G

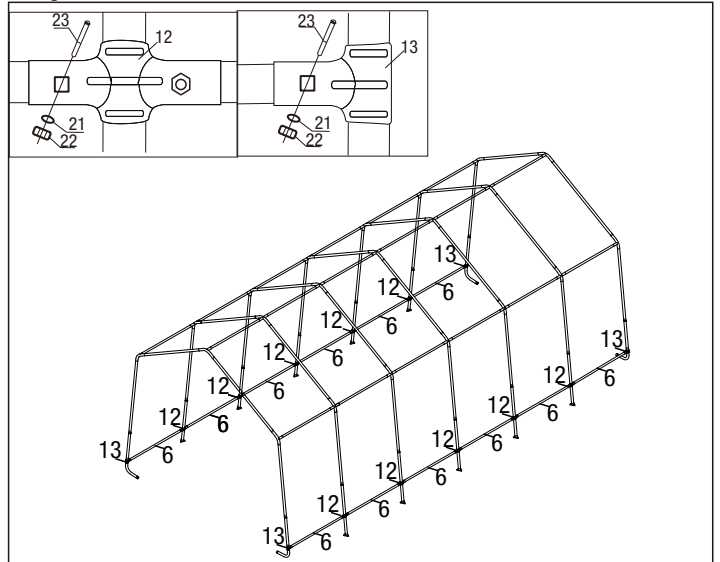

**Step 5: Square and Anchor the Frames**

- a. Check the measure of frame both 12' at the front and back corners, as well as the center.
- b. Take a diagonal measure as shown in Diagram H. When these two measures are equal the frame is square. Adjust the frame until they are equal to within 1".
- c. Once equal check the width measures again to ensure all are equal at 12'.
- d. Next, install Anchors (Part #14, #16 & #17) at the 4 Corner bent legs by screwing the removable anchor (#14) into the ground and to the inside of the shelter. Secure with Cable (#17) and Cable Clamp(#16) as shown in Diagram I.

Diagram H

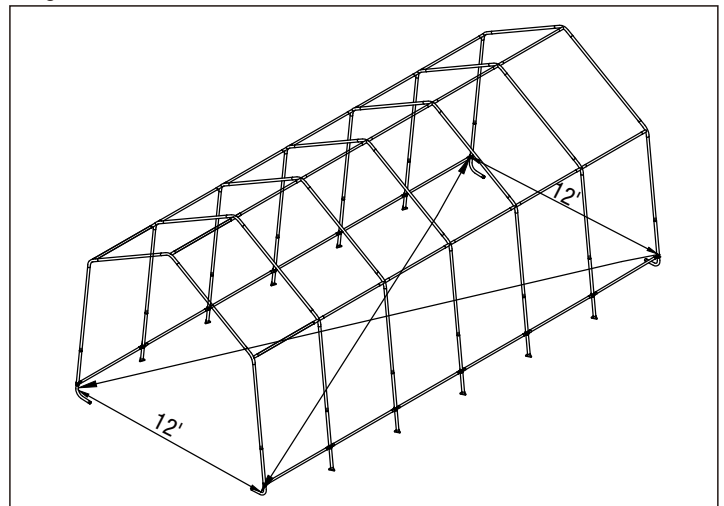
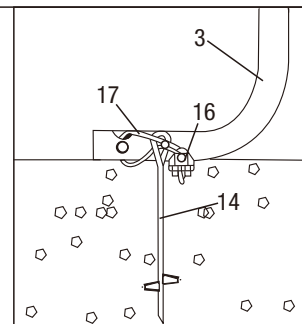

Diagram I



## Step 6: Installing the Front and Back Covers.

The front cover contains a zippered door to allow entry and exit to the shelter. Ensure to locate this cover to the desired end. Also, ensure the zipper is in the 'closed' position while installing. The back cover is a solid piece of polyethylene. The covers are installed in the same fashion.

- To make sure the strap will stay in the sleeve when assembly thread the strap through the spindle of the ratchet. Raise and lower the handle two or three times to wind the strap onto the spindle (see diagram J).
- Begin with the front cover and first locate the webbed belt that runs the perimeter of the cover. The webbing is exposed at the peak, the shoulders and the feet of the cover. At the feet of the cover, the webbing has two loose ends. Tie off the two loose ends of the webbed belt, one to each of the two corner legs.
- Next, using a rubber mallet, disconnect the shoulder pipe (#5) from the connector (#9 or #10) located between the leg and the roof pipes.
- Slip the webbed belt between pipe #5 and the connector (as shown in Diagram K). Rejoin the pipes.
- Repeat this step for the opposite shoulder.
- Move to the peak of the shelter using a step stool or ladder and, using a rubber mallet, disconnect the peak pipe (#5) from the connector (#7). Slip the webbed belt between the pipes (see Diagram K2) and reconnect.
- Next insert the S-hook of the ratchet into the pool of the corner leg and ratchet up/ down a couple of times to hold the ratchet and belt in place (Diagram L1).
- Repeat for the other loose end of the webbed belt.
- While one person remains on the stool and standing at the peak of the shelter, the other person tightens the ratchet, first at the foot of one corner leg and then moving over to the foot of the other corner leg.
- The person standing at the peak assists by ensuring the tarp is partially folded over the pipes of the end frame and inside or toward the interior of the shelter.
- Ensure the overlap of the cover flap remains square over the end frame and reaches the ground at the base while tightening the ratchets (Diagram L2).
- Repeat above steps for the other side of the Door Panel assembling.

**DO NOT OVERTIGHTEN RATCHETS AT THIS TIME!**

Diagram J

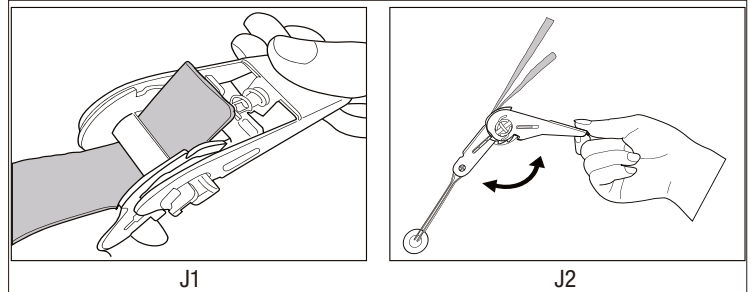

Diagram K

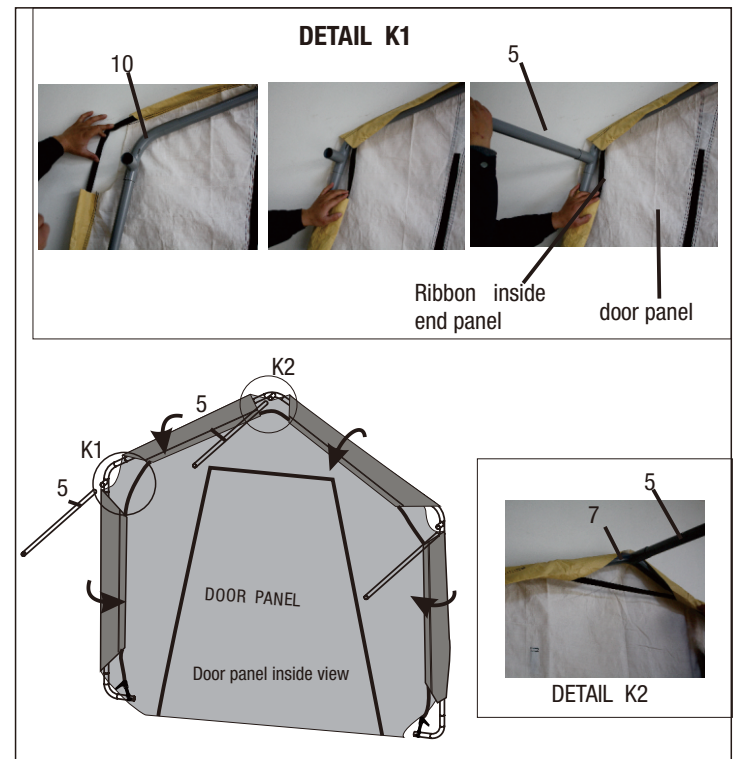
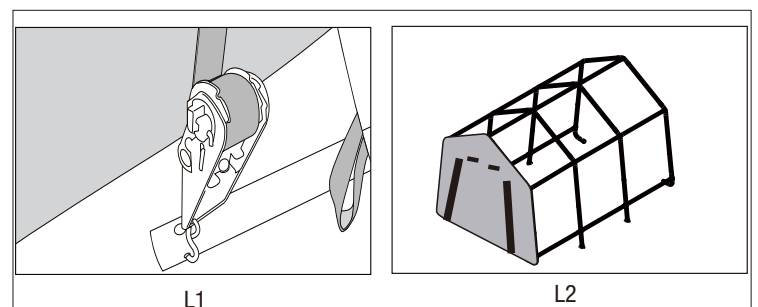

Diagram L



## Step 7: Installing the Main Cover

- Lay the cover on the ground next to the frame with inside of the cover (the side with pipe pockets) facing down and the webbing on the front and rear of the corner of the building.
- Tie one end of a rope to the eyelets on one corner of the cover, then another rope to the other corner eyelets.
- Pull cover over the frame by the help of the rope as (Diagram M), making sure to center cover on frame. There should be an equal amount of overhanging at all four corners.
- Assemble the ratchets (Patr #26) to the web ends on the 4 corner of the cover, 1 pc for each corner. Ratchet a few times to tighten the belt to the ratchet.
- Insert the "S"-hook on ratchet into hole on the Bent Corner Leg. Wind the ratchet so that the webbing overlaps itself.
- Disassemble cover rails and slide through fabric pockets at each leg and reattach with clamps to each leg. Repeat this on the other side. Push down on cover rails to tighten cover, before tightening bolts completely.
- When the cover rails are all secured, then proceed to the 4-corners and tighten the end covers to the end frames through the ratchet action.

**NOTE:** Over-tightening can cause damage to straps and/or the anchor point.

**DO NOT** over-tighten!

The shelter is now ready for use.

**Note :** Please check periodically (two to three times in the first week-weekly for the balance of the first month of set up) and tighten ratchet tie-downs and all hardware as needed. Monthly inspection is recommended throughout usage .

### Disassembly

When disassembling the shelter, depress the spring-loaded bar and open ratchet handle completely to allow the webbed belt to disengage the ratchet.

PLEASE RE-READ ALL WARNINGS CONTAINED ON PAGE 2 OF THESE INSTRUCTIONS. SAVE THESE INSTRUCTIONS FOR FUTURE USE.

To dismantle, execute all instructions in reverse order.

Store your shelter in a cool, dry location between seasons to prolong usable life of all components.

Components are not equally durable and will require replacement over time at differing intervals.

Diagram M

