

# SENTINEL CHICKEN COOP ASSEMBLY MANUAL

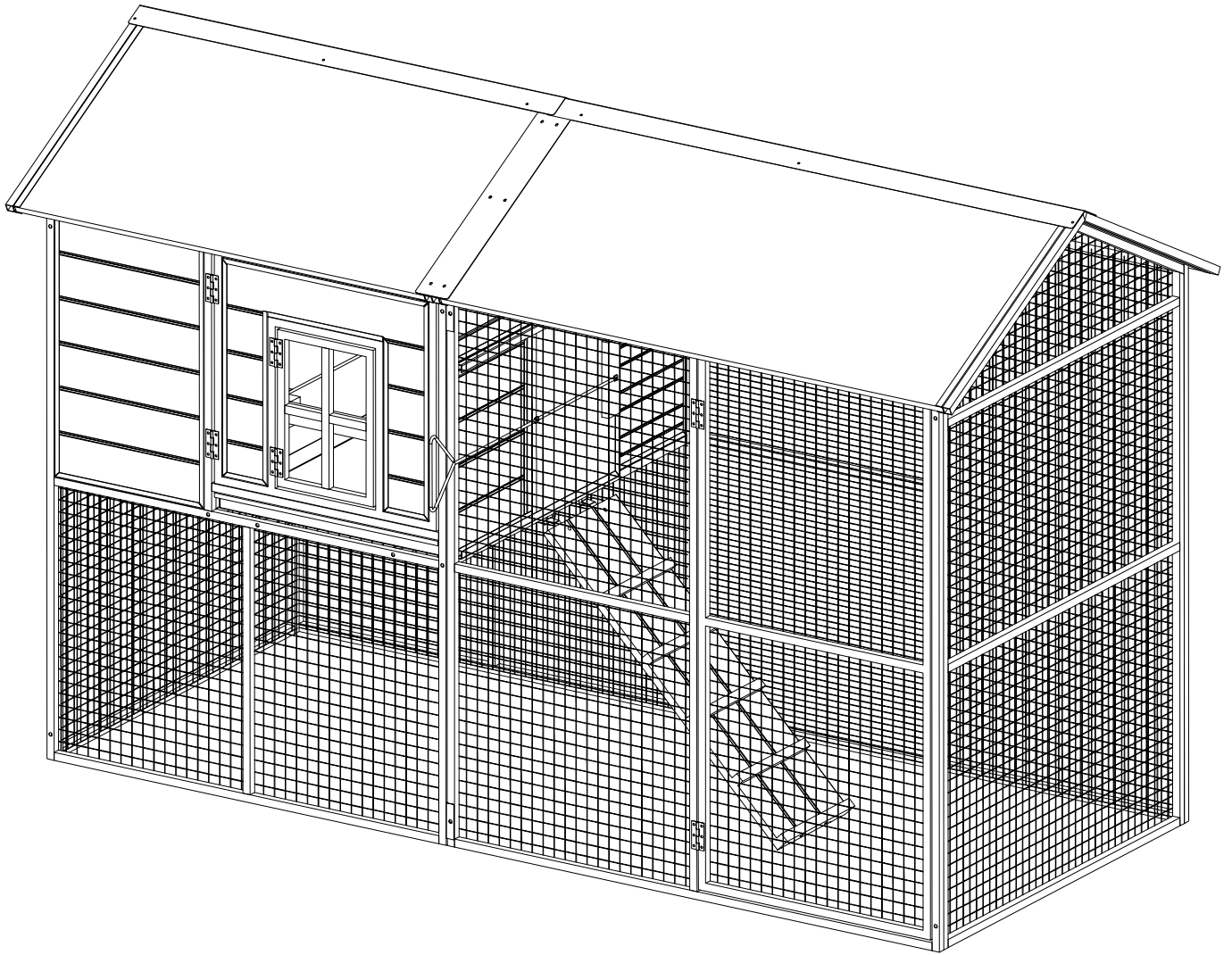

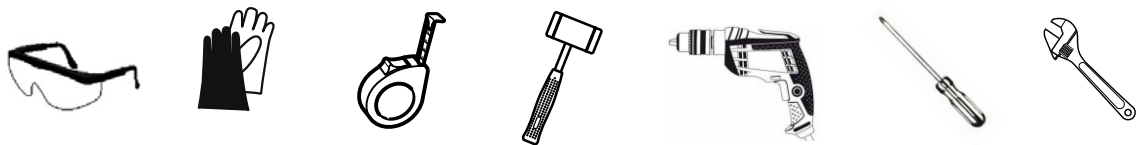





SKU#:133-1000S

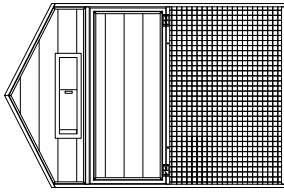
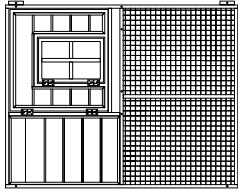
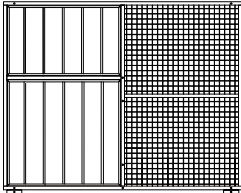

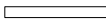
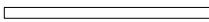



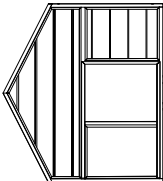





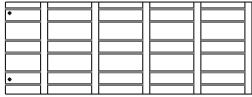

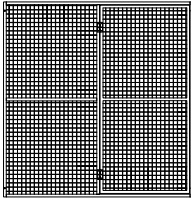
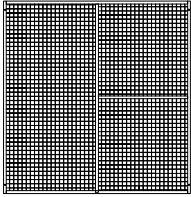
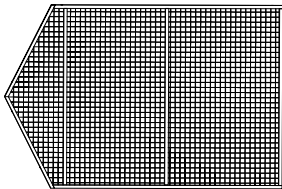

Tools required for assembly (not included)

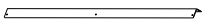
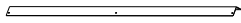

**PARTS LIST**

Part#	Description	Drawing	Qty.
1	<b>Coop Roosting Area Front Panel</b>		1
2	<b>Coop Roosting Area Right Panel</b>		1
3	<b>Coop Roosting Area Left Panel</b>		1
4	<b>Check Plate Support Bar</b>		1
5	<b>Check Plate</b>		1
6	<b>Nesting Box Support Bar</b>		2
7	<b>Tray Support Bar</b>		2
8	<b>Nesting Box Floor</b>		1
9	<b>Nesting Box Divider</b>		2
10	<b>Clean-out Tray</b>		1
11	<b>Roosting Bar</b>		2
12	<b>Coop Roosting Area Back Panel</b>		1
13	<b>Sliding Door</b>		1

**PARTS LIST**

Part#	Description	Drawing	Qty.
14	Ramp Hook		2
15	Ramp		1
16	Push-Pull Rod		1
17	Pen Right Panel		1
18	Pen Left Panel		1
19	Pen Front Panel		1
20	Coop Roosting Area Right Roof		1
21	Coop Roosting Area Left Roof		1
22	Pen Right Roof Panel		1
23	Pen Left Roof Panel		1
24	Coop Roosting Area Roof Cap		1
25	Pen Roof Cap		1
26	Junction Plate		2
27	M6x30 Bolt		36+1
28	M6 Lock Nut		6
29	Self-Tapping Screw 3.5x13		34+3
30	Tapping Screw 3.5x13		2
31	M4x20 Bolt		1
32	Lock		3
33	Waterproof washer		8

**Step 1**

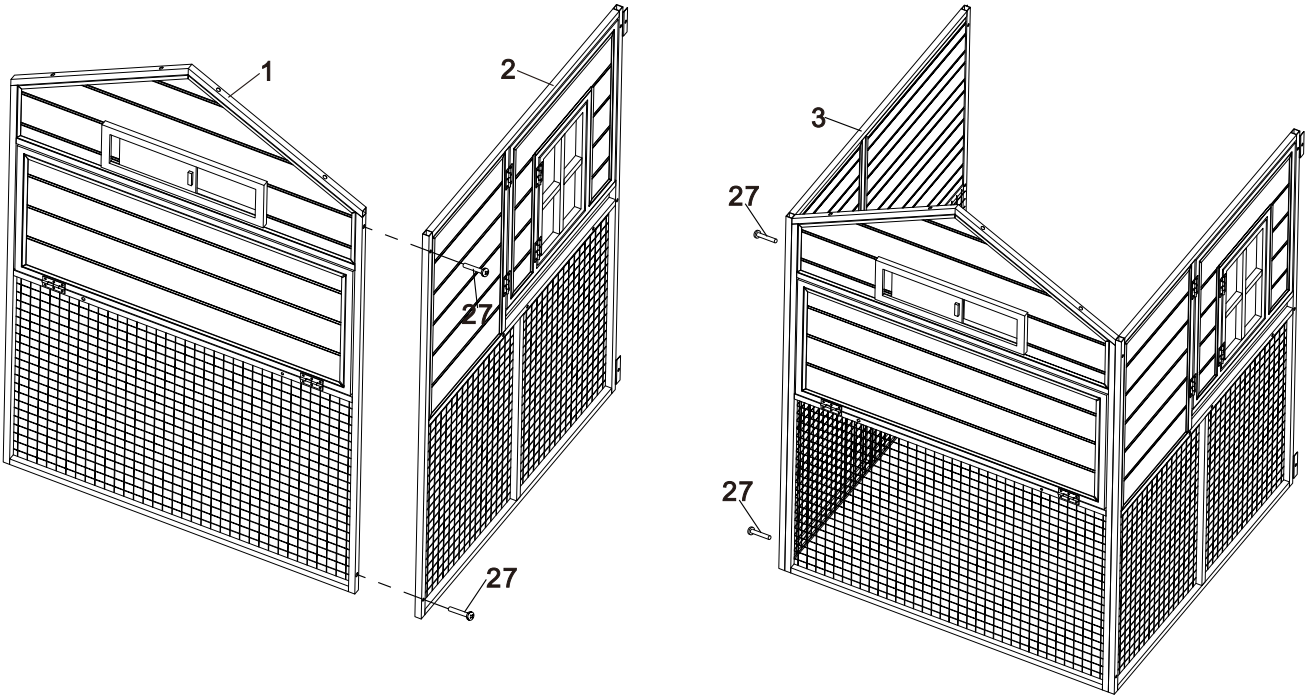

- Connect Coop Roosting Area Front Panel and Coop Roosting Area Right Panel (#1 & #2) with M6x30 Bolt (#27) .  
Connect Coop Roosting Area Left Panel (#3) to the other side of above structure with M6x30 Bolt (#27).  
Make sure the bottom of each panel is aligned properly.

**Step 2**

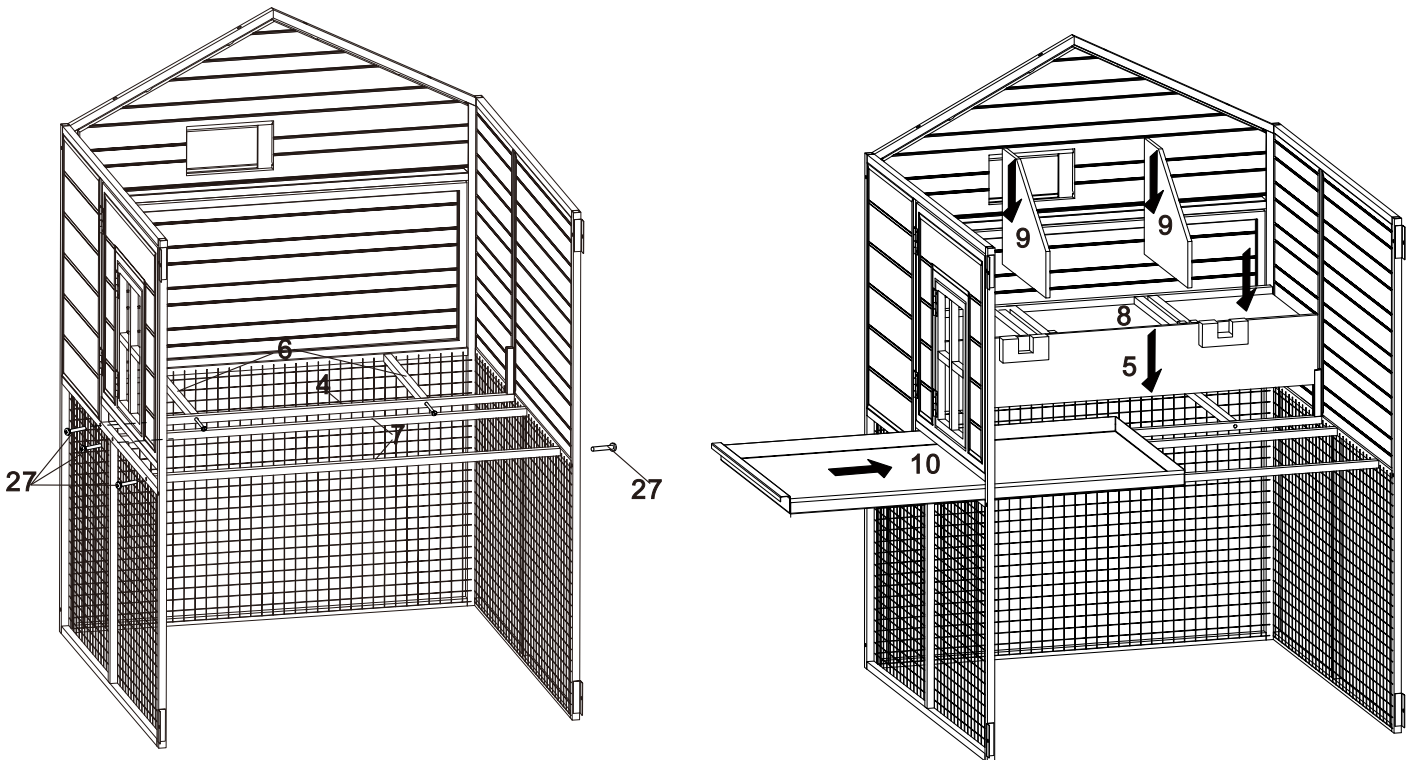

- Fix the 2pcs Nesting Box Support Bar(#6) & 1pc Check Plate Support Bar (#4) and 2pcs Clean Tray Support Bar (#7) as below diagram,with M6x30 Bolt (#27).  
Put the Nesting Box Floor (#8) on top of Bar (#6), and then insert the two Nesting Box Divider (#9) as the diagram.  
Put the Check Plate (#5) on top of Bar (#4), and Insert the Clean-out Tray (#10) through the slot on the Right Panel of the Coop.



**Step 3**

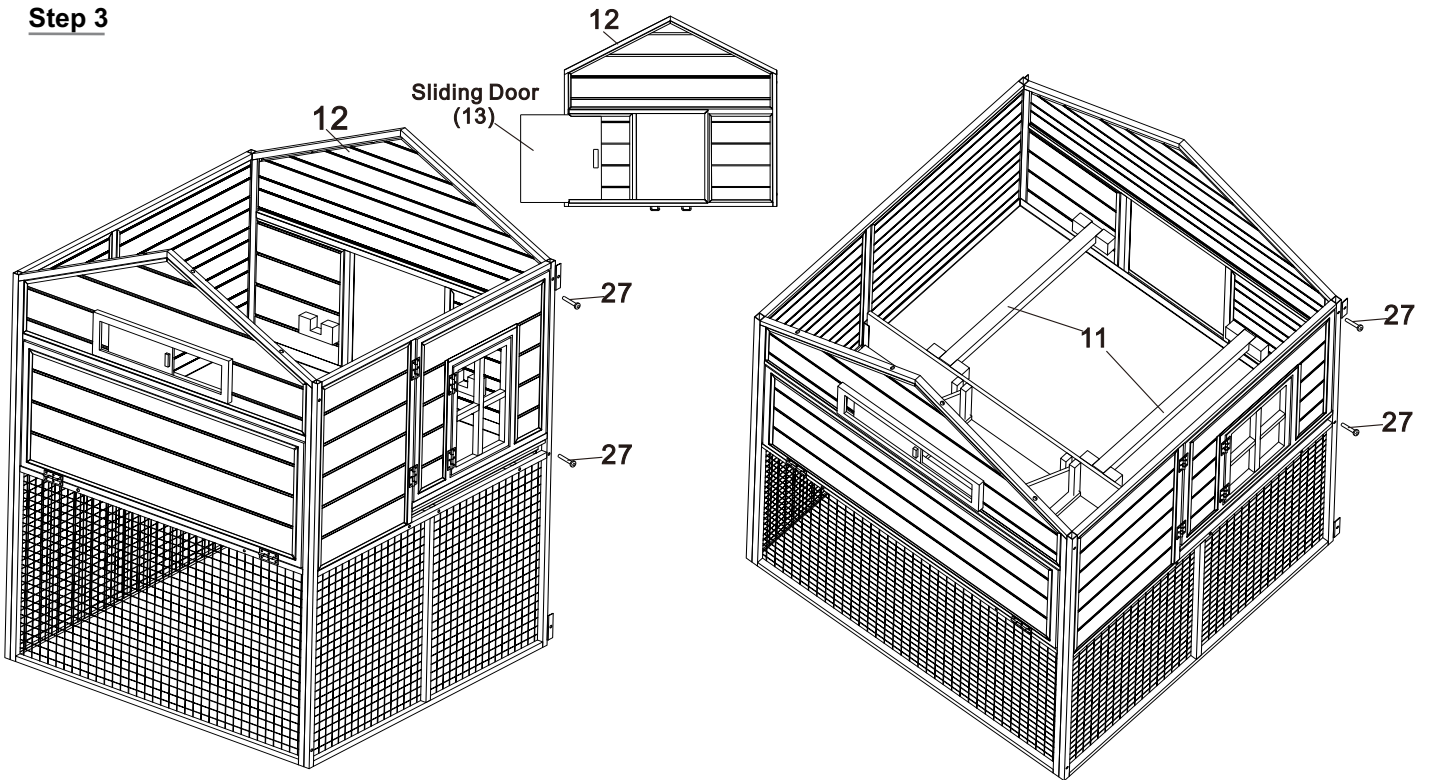

- Insert the Sliding Door (#13) into the Coop Front Panel(#12).  
Assemble the Coop Roosting Area Back Panel (#12) with M6x30 bolt (#27).  
Place the Roosting Bar (#11) in the position as shown.

**Step 4**

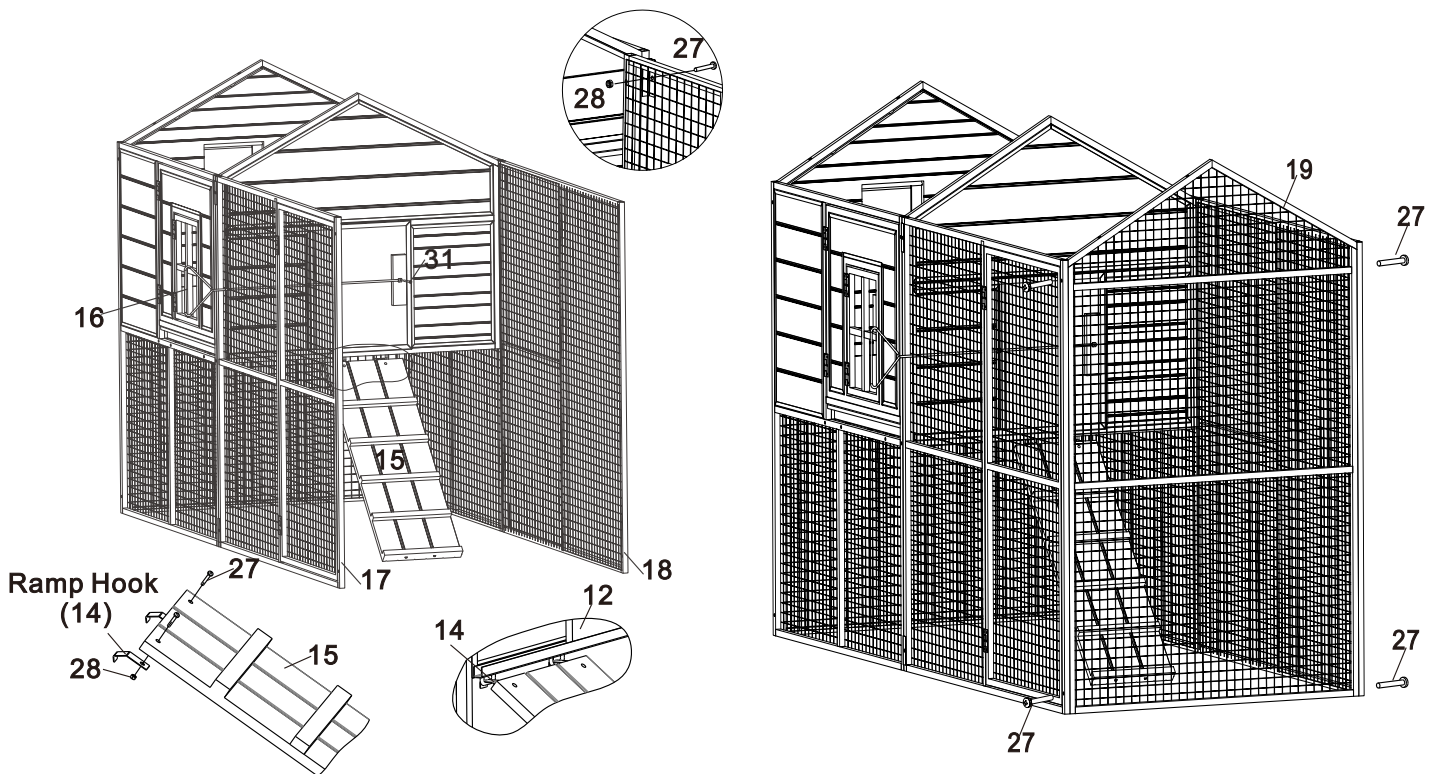

- Assemble the Pen Right Panel (#17) and Pen Left Panel (#18) with M6x30 bolt (#27) and Nuts M6 (#28).  
Fix the 2pcs Ramp Hooks (#14) to one end of the Ramp (#15) as below diagram.  
Hook the Ramp on the Coop Roosting Area Back Panel.  
Thread the push-pull rod (16) through the hole on the frame and secure the other end to the sliding door with bolt (31)  
Then assemble the Pen Front Panel (#19) with Bolt M6x30 (#27)

**Step 5**

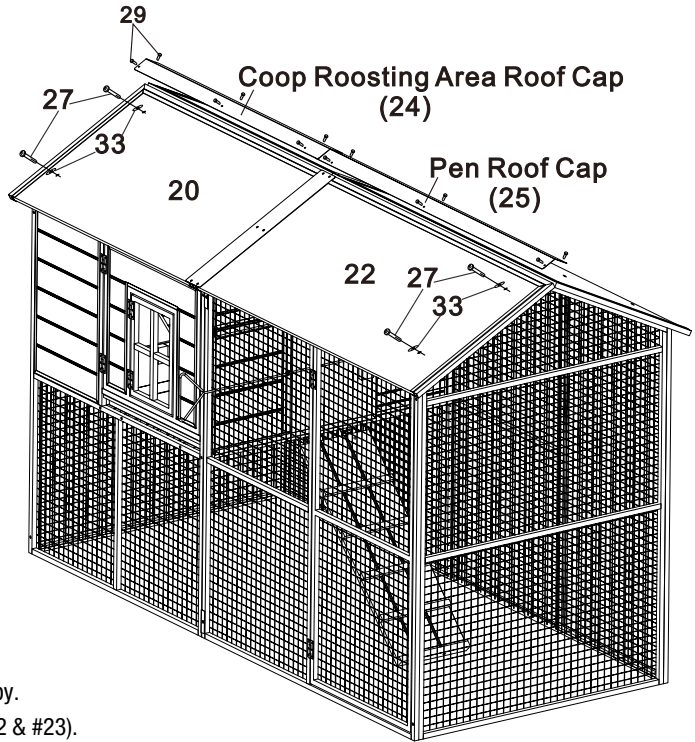
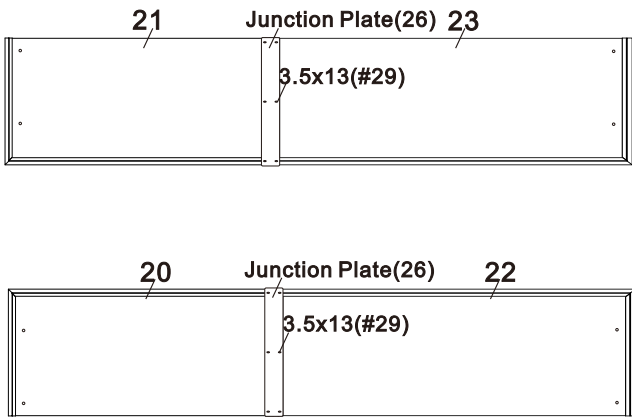

- Attach the Nesting Box Roof Panel (#29) and Junction Plate (#26) by Coop Roosting Area Left Roof (#20 & #21) and Pen Left Roof Panel (#22 & #23). Attach the Roof Panels (2pcs) with M6x30 bolt (#27) and Waterproof washer (#33). And then fix the Roof Cap (#24 & #25) with #29 screws.

**Step 6**

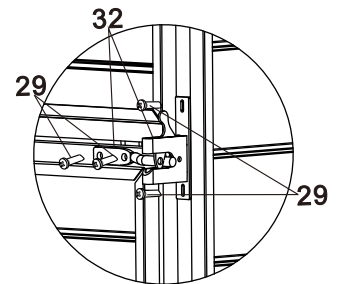
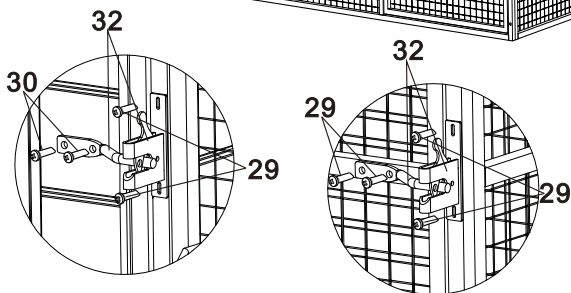
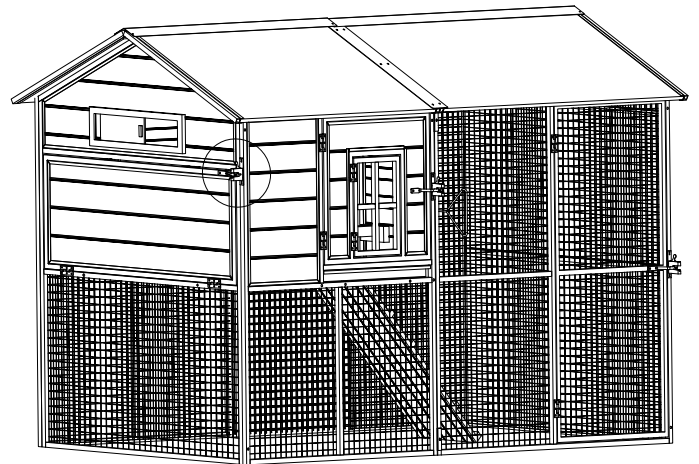
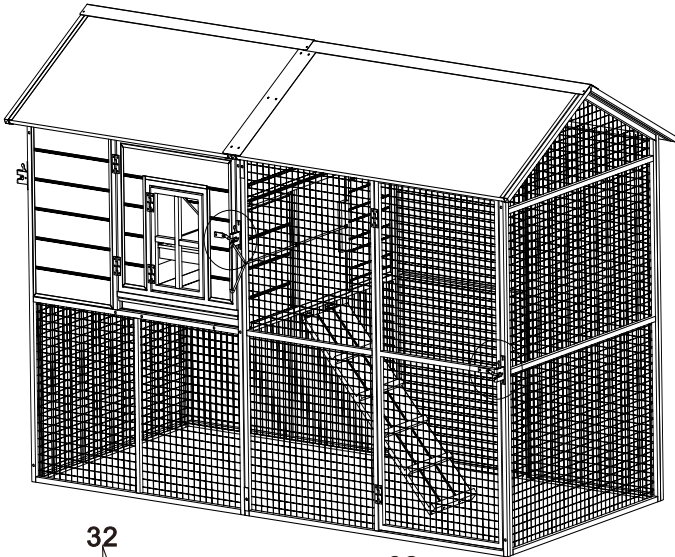

- Assemble 3pcs Lock (#32) on the panel as diagram, using Tapping Screws (#29 & #30). The coop now is fully assembled and ready to use.